

INSTALLATION GUIDELINES

# Secura Grand



SECURA GRAND

# Gravity Wall

A gravity retaining wall relies solely on the weight and setback of the segmental concrete blocks to resist pressure and retain the soil behind it.

Secura Grand can be constructed as a gravity wall to a maximum retained height of 1m in situations where there is no crest or toe slope and no surcharge above the wall. The simplicity of the Secura Grand Gravity mortarless build technique makes it highly efficient for low walls.

**Suitability**

Max retained height

**1m**

Level

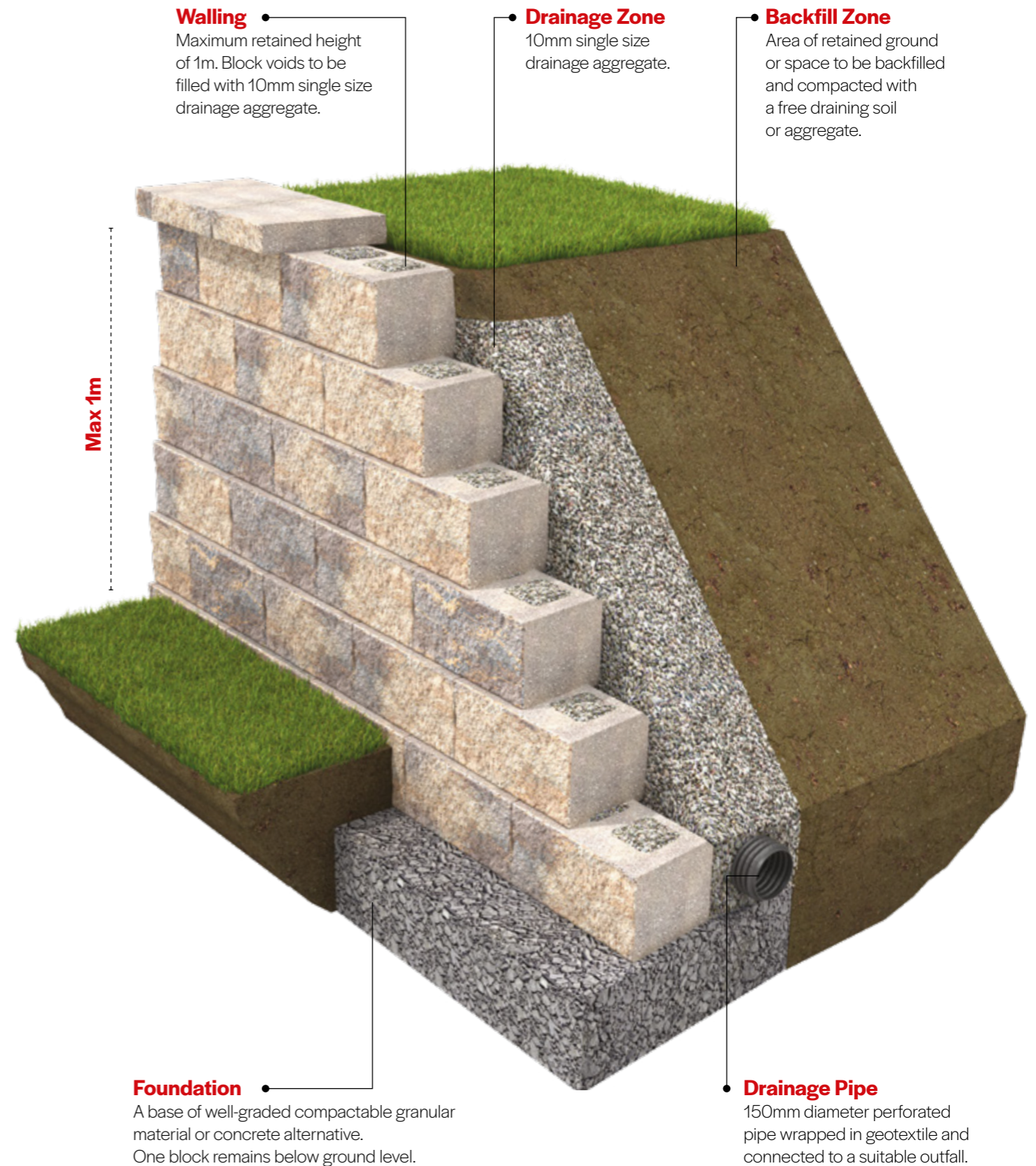

**Backfill Zone**



Free draining soil or aggregate.

**Drainage Zone**



10mm single size drainage aggregate.

**Mortarless Installation**

When installed with an aggregate foundation, the Secura Grand gravity wall remains completely mortarless.

# Secura Grand Gravity Wall Installation

**Preliminary actions**

**STRUCTURAL DESIGN**  
**Important:** The design of any retaining wall requires the input of an engineer to assess the unique conditions of every site in respect of loads in conjunction with site and soil conditions. The advice and typical wall designs in this guide are for information only to assist estimating and initial planning but should not be used for construction.

**WORKING SAFELY**  
**Important:** Please refer to our safety notes on page 20 prior to commencement of any site works.

**BATCH ORDERING**  
**Important:** If using a solid colour (Charcoal, Natural or Golden) please ensure you order from one manufacturing batch to avoid any colour shading which may occur.

**FILL MATERIALS**  
**Important:** Please ensure that the specified fill materials (see page 18) are available on site before commencement.

**Important:** The maximum gravity wall retained height is 1m on a site with no toe or crest slope and zero surcharge. Please review the geogrid or concrete reinforced options if the gravity option is not possible.

**Step 1**  
**Setting out & trench excavation**

- Mark out the location of the wall by checking the design drawings or by agreement with the project engineer, architect or client.
- Please refer to the table below for typical foundation details or if there is an engineers' site-specific design. This should be followed at all times. (Please refer to the table below for dimensions and recommended block courses below ground)
- Excavate the trench to a minimum 400mm depth and 600mm width. Remove any unsuitable material and replace it with compacted granular material. See specification for material on page 18. Ensure it is fully compacted using a plate compactor.

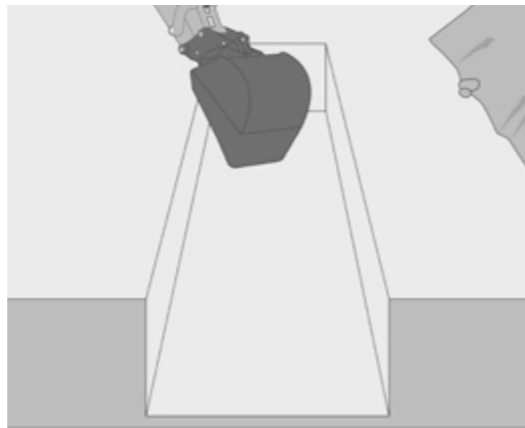

**Step 2**  
**Laying the foundation**

- Important:** If the line of the wall is on a gradient, the foundation must be stepped. The top of the foundation must be at least 200mm below finished ground level. Lay a level foundation using one of the following two options:
- Granular material option:** Lay a well-graded compactable granular material as specified on page 18 and compact fully using a plate compactor to ensure a level base. The typical depth of the foundation should be 200mm after compaction.
  - Concrete option:** Install a 200mm deep concrete foundation using C20/25 concrete.

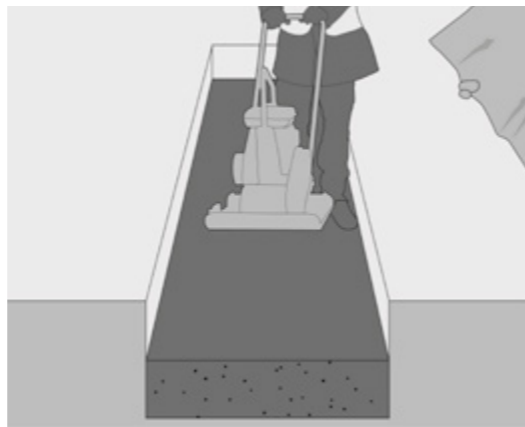

Product	Min. internal radius	Max. external radius	Typical trench width (mm)	Typical trench depth (mm)	Foundation material	Typical foundation depth (mm)	Block courses below ground
Secura Grand	2.4m to the back of the base course block or 2.17m to the front.	This will be dependent on the height of the wall. Please refer to page 86 of our Secura brochure.	600 mm	400mm to accommodate one block plus foundation depth	Well-graded compactable material or C20/25	200 mm	1 (unless specified differently on the design drawings)

**Step 3**  
**Installing the base course**

- Important:** The top of the base course when installed must be below finished ground level.
- Block selection**  
Please ensure that you randomly select blocks from a minimum of three packs to achieve the desired colour blend. This should be done on the base course and for all other courses.
- Block preparation**  
To ensure a level base course, remove the nib from the base of the blocks to be used on the base course using a bolster and club hammer.
- Block Placement**  
Place the blocks onto the foundation and use a string line along the back of the blocks to check for alignment. Use a spirit level to ensure the blocks are level along their length and from front to back as the aesthetics of the finished wall depend on the base course being level. Leave a gap of 2mm between the blocks to allow for any movement of the ground.
- Front fill**  
Fill the gap in front of the base course with on-site soil and fully compact, level with the base course.

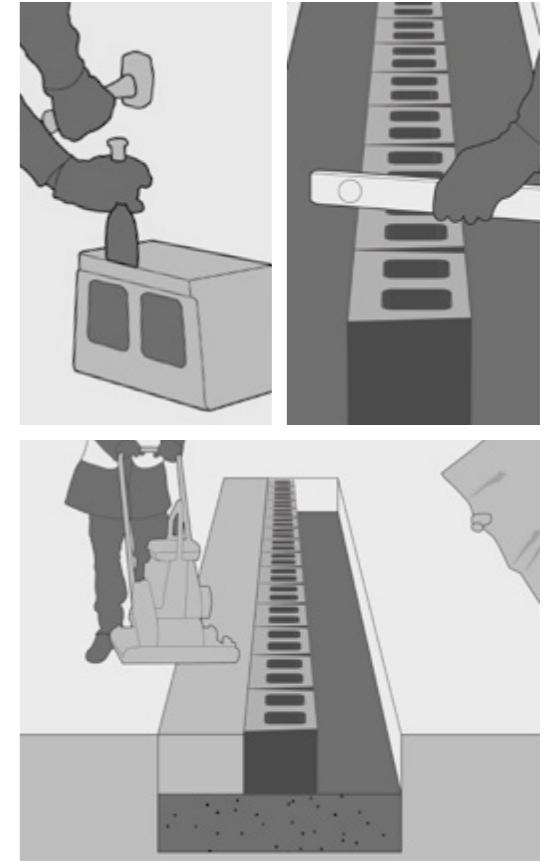

**Step 4**  
**Laying drainage pipe**

- Drainage Pipe**  
Lay a perforated drainage pipe centred on a line 150mm from the back of the base course. The pipe should connect to a suitable outlet/soakaway. The pipe can be wrapped in a geotextile to prevent clogging.
- Fill the Block Voids**  
Completely fill the two voids in each block with 10mm single size drainage aggregate. This requires approximately 9kg of 10mm drainage aggregate per block.

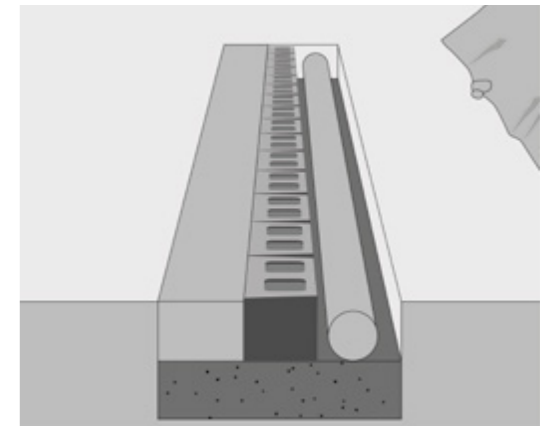

# Secura Grand Gravity Wall Installation

## Step 5 Backfill the drainage material

- Backfill the base course blocks to a distance of 300mm with 10mm drainage aggregate covering the perforated drainage pipe. Backfill until it is just under the top of the base course blocks to allow space for the nib on the next course. Subsequent layers will form a 300mm wide drainage column behind the wall.
- **Important:** Do not compact the drainage material.

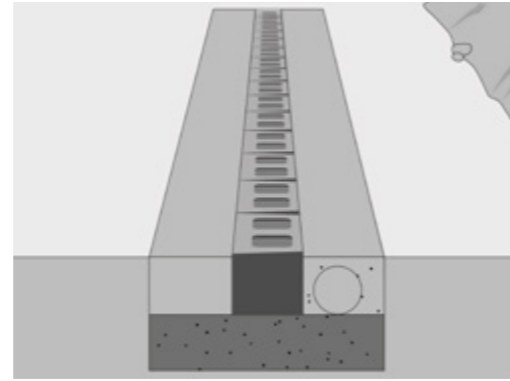

## Step 6 Laying further block courses

- Place the blocks on top of the base course ensuring that they are in running bond pattern in relation to the blocks on the base course. Vertical joints should not directly line up between courses. Push the blocks forward until the nib on the base of the block tightly locates against the blocks beneath.
- Use a spirit level to ensure the blocks are level as you build each course. Due to Secura's mortarless construction, the use of shims may be required occasionally to maintain level in the block course.
- Backfill 300mm drainage column.
- Fill the voids in each block with 10mm single size drainage aggregate. This requires approximately 9kg of 10mm drainage aggregate per block.
- Build the wall up a maximum of a further two courses.
- **Important:** Never build any higher than three courses before backfilling.

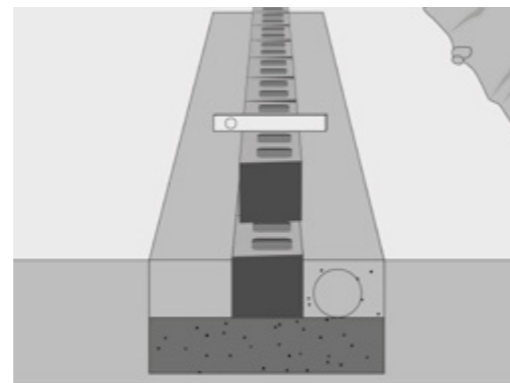

## Step 7 Backfilling the area behind the drainage zone

- Backfill the remainder of the space behind the drainage zone in maximum 200mm lifts with a free draining soil or aggregate and compact the backfill material until it is level with the drainage aggregate.
- Brush the top surface of the blocks to remove any debris which may affect the wall level prior to laying subsequent layers.
- **Important:** Do not compact the 10mm drainage column. Tracked machines, vibrating or static rollers should not be used within 1 metre from the back of the wall.

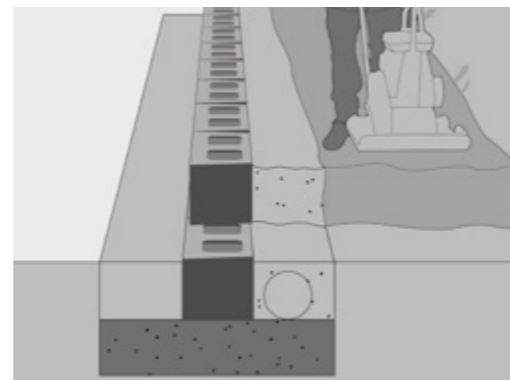

## Step 8 Completing the wall

- Repeat this process until you have reached the maximum gravity wall height of 1m (maximum 6 courses including base course). Top off with soil.
- **Copings:** To install the copings use a concrete exterior grade construction adhesive applied with a cartridge gun. Generously apply the adhesive to the block. For extra stability the last two courses of blocks can be bonded together as well as the coping blocks.

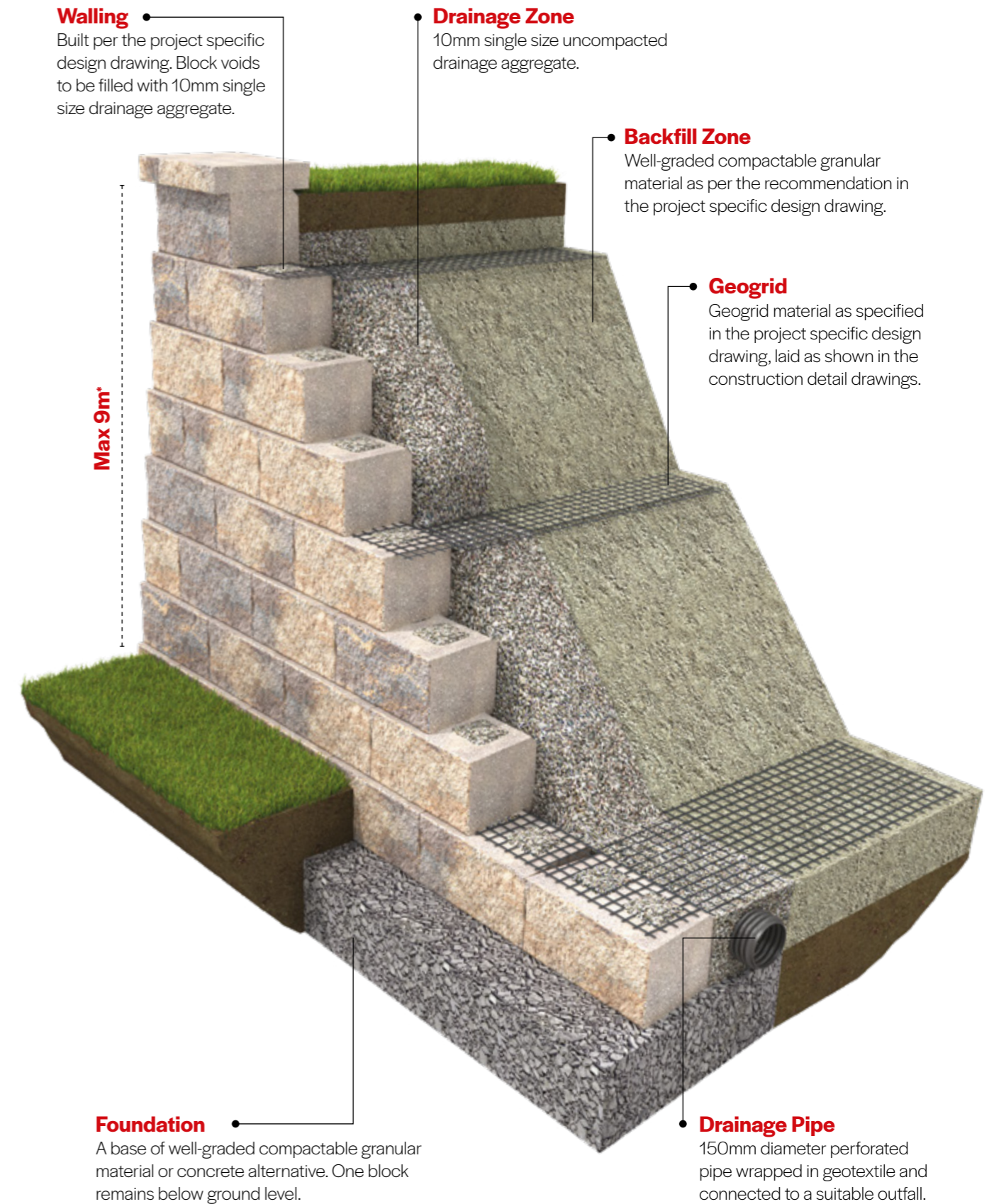

\*For walls higher than 9m please contact Tobermore technical department

# Secura Grand Geogrid Reinforced Wall Installation

**Preliminary actions**

**STRUCTURAL DESIGN**  
**Important:** The design of any retaining wall requires the input of an engineer to assess the unique conditions of every site in respect of loads in conjunction with site and soil conditions. The advice and typical wall designs in this guide are for information only to assist estimating and initial planning but should not be used for construction.

**WORKING SAFELY**  
**Important:** Please refer to our safety notes on page 20 prior to commencement of any site works.

**BATCH ORDERING**  
**Important:** If using a solid colour (Charcoal, Natural or Golden) please ensure you order from one manufacturing batch to avoid any colour shading which may occur.

**FILL MATERIALS**  
**Important:** Please ensure that the specified fill materials (see page 18) are available on site before commencement.

**Step 1**  
**Setting out & trench excavation**

- Mark out the location of the wall by checking the design drawings or by agreement with the project engineer, architect or client.
- Please refer to the table below for typical foundation details or if there is an engineer's site-specific design this should be followed at all times. (Please refer to the table below for dimensions and recommended block courses below ground)
- Excavate the trench to a minimum 400mm depth and 600mm width. Remove any unsuitable material and replace it with compacted granular material. See specification for material on page 18. Ensure it is fully compacted using a plate compactor.

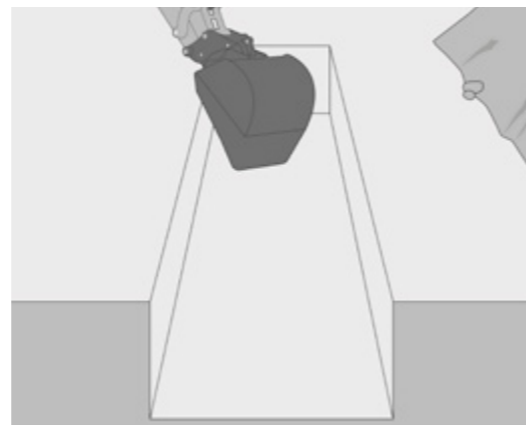

**Step 2**  
**Laying the foundation**

- Important:** If the line of the wall is on a gradient, the foundation must be stepped. The top of the foundation must be at least 200mm below finished ground level. Lay a level foundation using one of the following two options:
  - Granular material option:** Lay a well-graded compactable granular material as specified on page 18 and compact fully using a plate compactor to ensure a level base. The typical depth of the foundation should be 200mm after compaction.
  - Concrete option:** Install a 200mm deep concrete foundation using C20/25 concrete.

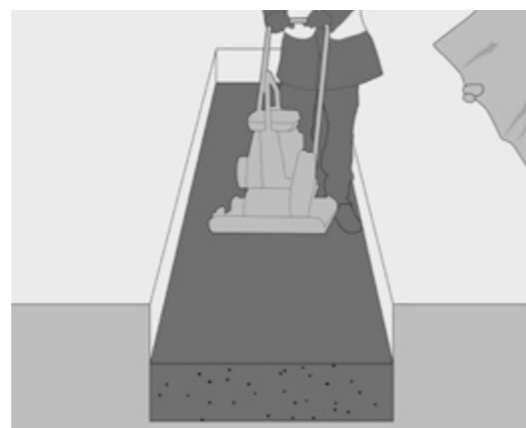

**Step 3**  
**Installing the base course**

- Important:** The top of the base course when installed must be below finished ground level.
- Block selection**  
 Please ensure that you randomly select blocks from a minimum of three packs to achieve the desired colour blend. This should be done on the base course and for all other courses.
- Block preparation**  
 To ensure a level base course, remove the nib from the base of the blocks to be used on the base course using a bolster and club hammer.
- Block Placement**  
 Place the blocks onto the foundation and use a string line along the back of the blocks to check for alignment. Use a spirit level to ensure the blocks are level along their length and from front to back as the aesthetics of the finished wall depend on the base course being level. Leave a gap of 2mm between the blocks to allow for any movement of the ground.
- Front fill**  
 Fill the gap in front of the base course with on-site soil and fully compact, level with the base course.

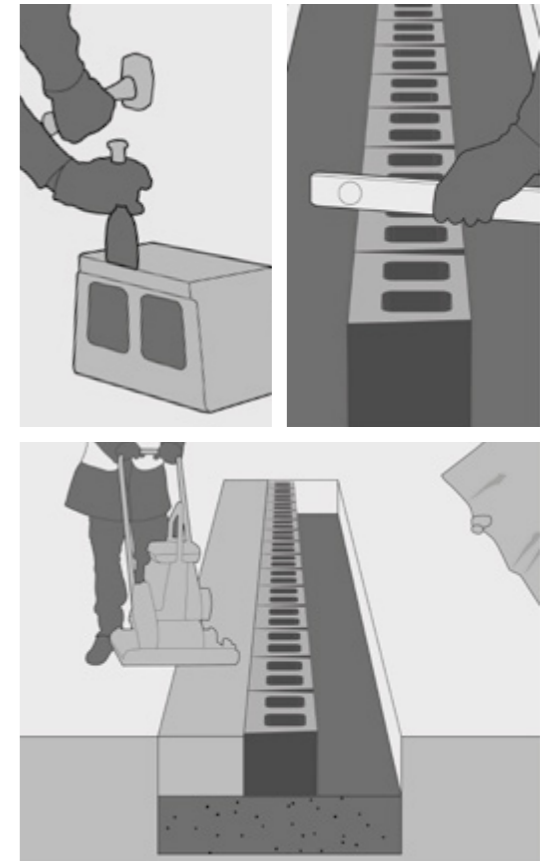

**Step 4**  
**Laying drainage pipe**

- Drainage Pipe:** Lay a perforated drainage pipe centred on a line 150mm from the back of the base course. The pipe should connect to a suitable outlet/soakaway. The pipe can be wrapped in a geotextile to prevent clogging.
- Fill the Block Voids:** Completely fill the two voids in each block with 10mm single size drainage aggregate. This requires approximately 9kg of 10mm drainage aggregate per block.

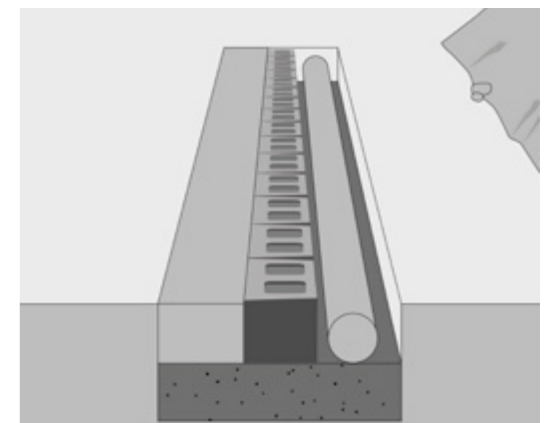

Product	Min. internal radius	Max. external radius	Typical trench width (mm)	Typical trench depth (mm)	Foundation material	Typical foundation depth (mm)	Block courses below ground
Secura Grand	2.4m to the back of the base course block or 2.17m to the front.	This will be dependent on the height of the wall. Please refer to page 86 of our Secura brochure.	600 mm	400mm to accommodate one block plus foundation depth	Well-graded compactable material or C20/25	200 mm	1 (unless specified differently on the design drawings)

# Secura Grand Geogrid Reinforced Wall Installation

## Step 5 Backfill the drainage material

- Backfill the base course blocks to a distance of 300mm with 10mm drainage aggregate covering the perforated drainage pipe. Backfill until it is just under the top of the base course blocks to allow space for the nib on the next course. Subsequent layers will form a 300mm wide drainage column behind the wall.
- Compact the backfill zone until it is level with the drainage aggregate and the base course blocks.
- Important:** Do not compact the drainage material.

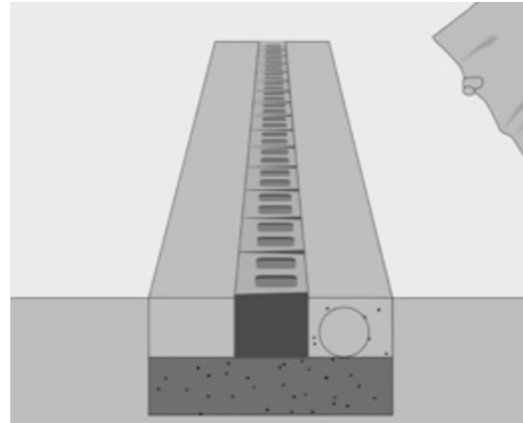

## Step 6 Installing the geogrid

- Geogrid design & type**  
On most projects the first layer of geogrid will be installed on top of the base course (check this with the tables on page 64 of our Secura brochure and the correct height specific design drawing).  
For walls which do not need to meet BBA HAPAS standards Tobermore recommend using high quality geogrids such as Tensar, Wrekin and Heusker Fortrac etc.  
**Important:** For all geogrid reinforced retaining walls designed in accordance with BBA/HAPAS, Heusker Fortrac geogrids must be used. No substitutes are allowed. Heusker Fortrac geogrids are available from Tobermore.
- Geogrid placement**  
Place the specified strength of geogrid on top of the base course blocks (free from debris), ensuring that it is 25mm back from the front edge of the blocks.  
Roll the geogrid out flat over the drainage aggregate and backfill material and pull it taut to remove any folds or wrinkles. Cut the geogrid to the specified length (check the design drawings).
- Orientation and butting**  
**Important:** Ensure that the principal reinforcement direction is perpendicular to the wall.  
Ensure that the geogrid is butt jointed and never overlapping between the Secura blocks.

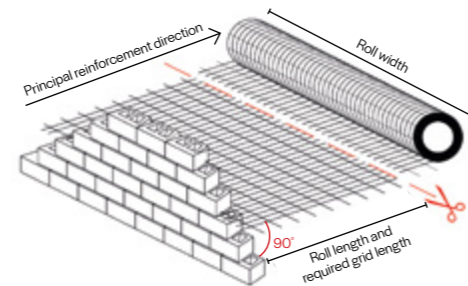
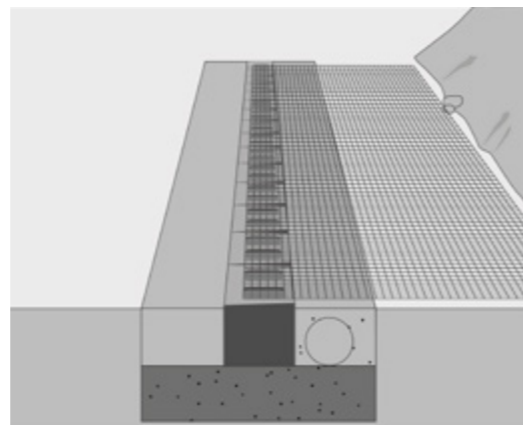

## Step 7 Backfilling the reinforced zone

- Using a well-graded granular compactable material, backfill the remainder of the reinforced zone to the distance from the rear of the wall as specified in the design drawing. See specification for the backfill material on page 18.
- Brush the top surface of the blocks to remove any debris which may affect the wall level prior to laying subsequent layers.
- Important:** Site won material may be used in the reinforced zone ONLY IF IT COMPLIES with the specifications on page 18, and is in accordance with the Manual of Contract Documents for Road Works - Specification of Highway Works, Series 600. Testing should be carried out to confirm this prior to use.

## Step 8 Laying further block courses

- Place the blocks on top of the base course and geogrid ensuring that they are in running bond pattern in relation to the blocks on the base course. Vertical joints should not directly line up between courses.
- Push the blocks forward until the nib on the base of the block tightly locates against the blocks and the geogrid beneath.
- Use a spirit level to ensure the blocks are level as you build each course. Due to Secura's mortarless construction, the use of shims may be required occasionally to maintain level in the block course.
- Fill the voids in each block with 10mm single size drainage aggregate. This requires approximately 9kg of 10mm drainage aggregate per block.
- Build the wall up a further three courses or to the specified course where the next layer of geogrid is to be installed.  
**Important:** Never build any higher than three courses before backfilling.
- Backfilling Process**  
**Backfill zone:** Place the backfill material on the geogrid and spread it out in the reinforced zone away from the 300mm drainage column. The backfill material should be placed and compacted in 200mm lifts, using a plate compactor, working away from the edge of the drainage column.  
**Important:** Tracked machines should not directly traffic over the geogrid. Vibrating or static rollers should not be used within 1 metre from the back of the wall.
- Drainage Column:** Fill the gap between the wall and the backfill with 10mm single size drainage aggregate.  
**Important:** Do not compact the 10mm drainage aggregate.

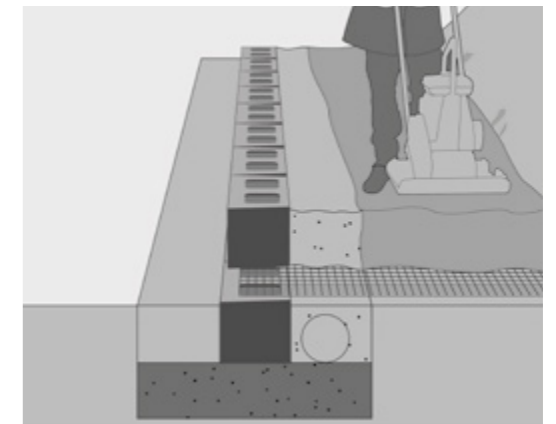
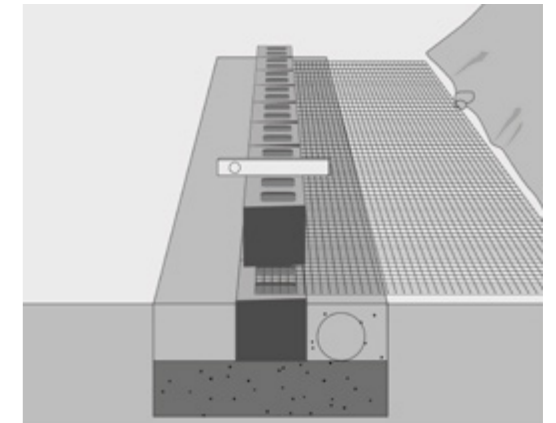

## Step 9 Completing the wall

- Continue building the wall, filling the block voids, backfilling with drainage aggregate, backfill material and compacting. Install the geogrid at the correct locations as specified in the height specific design drawing. Geogrid layers can be installed and then placed over the face of the wall until backfilling and compacting is complete. It can then be brought back over and pulled taut on top of the levelled backfill material and staked into position.  
Top off the area behind the wall with soil.
- Copings**  
To install the Secura copings use a concrete exterior grade construction adhesive applied with a cartridge gun. Generously apply the adhesive to the block. For extra stability the last two courses of blocks can be bonded together as well as the coping blocks.

### **Important: Permitted block tolerances**

Segmental Block Retaining walls are designed to be flexible structures which can tolerate some horizontal and vertical movement. Construction tolerances are permitted due to the nature of the system. Even with stringent quality control measures in place at the factory, modular block units may vary in height. Therefore, adjustments may need to be made to allow for the mortarless construction method.

It is an accepted construction practice in segmental block retaining structures to use shims under the blocks to compensate for a build-up of tolerances or an out of level base condition.

The level of the wall should be checked every 3rd course. Any adjustments necessary can be made using shims placed between the blocks. Shims should not be used on courses where there is a layer of geogrid to be installed. Cut pieces of geogrid or asphalt shingles are suitable to be used as shims. The maximum allowable shim thickness per course is 3 mm

SECURA GRAND

# Concrete Backfill Reinforced Walls

The concrete backfill reinforced wall is ideal for use on sites where backfill space is limited or where it is preferable to avoid the greater amount of excavation which is required for a geogrid reinforced wall.

A no-fines concrete backfilled wall reduces the length of excavation required to approximately 40% of the overall wall height compared to the 70% required for a geogrid reinforced wall.

The Secura Grand blocks work in combination with the concrete backfill which attaches itself to the blocks, creating a homogenous mass. The width of the concrete backfill material required will vary depending on wall height, ground conditions and the surcharge above the wall.

**No-Fines Concrete**

No-fines concrete is a cost-effective backfill which also acts as the drainage zone. Unlike normal concrete, no-fines concrete eliminates the need for fine aggregates by using a thin layer of cement paste to hold the aggregates together and provide the strength. Due to the open texture, no-fines concrete provides good drainage properties.

The alternative option is to use a C20/25 structural concrete in combination with a layer of drainage geocomposite between the concrete and retained soil.

**Structural Concrete for reduced excavation**

When space is at a premium it is possible to reduce the distance behind the wall by a further 150mm by using C20/25 structural concrete as an alternative to no-fines concrete. When using this installation method, a layer of geocomposite is installed between the structural concrete and the retained soil.

**Backfill Zone**

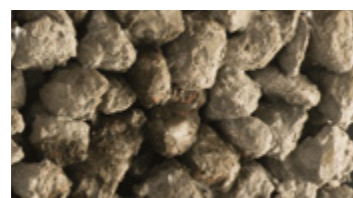

No-fines concrete or C20/25 structural concrete.

**Drainage Zone**



10mm single size drainage aggregate.

**Suitability**

Max retained height

No-fines concrete	Structural concrete
<b>4m*</b>	<b>6m*</b>

Level

Surcharge

Slopes



No-fines concrete

**Geotextile/Geocomposite**

Geotextile with no-fines concrete. Geocomposite with C20/25 structural concrete.

**No-fines Concrete Backfill Reinforced Wall** (max retained height 4m)

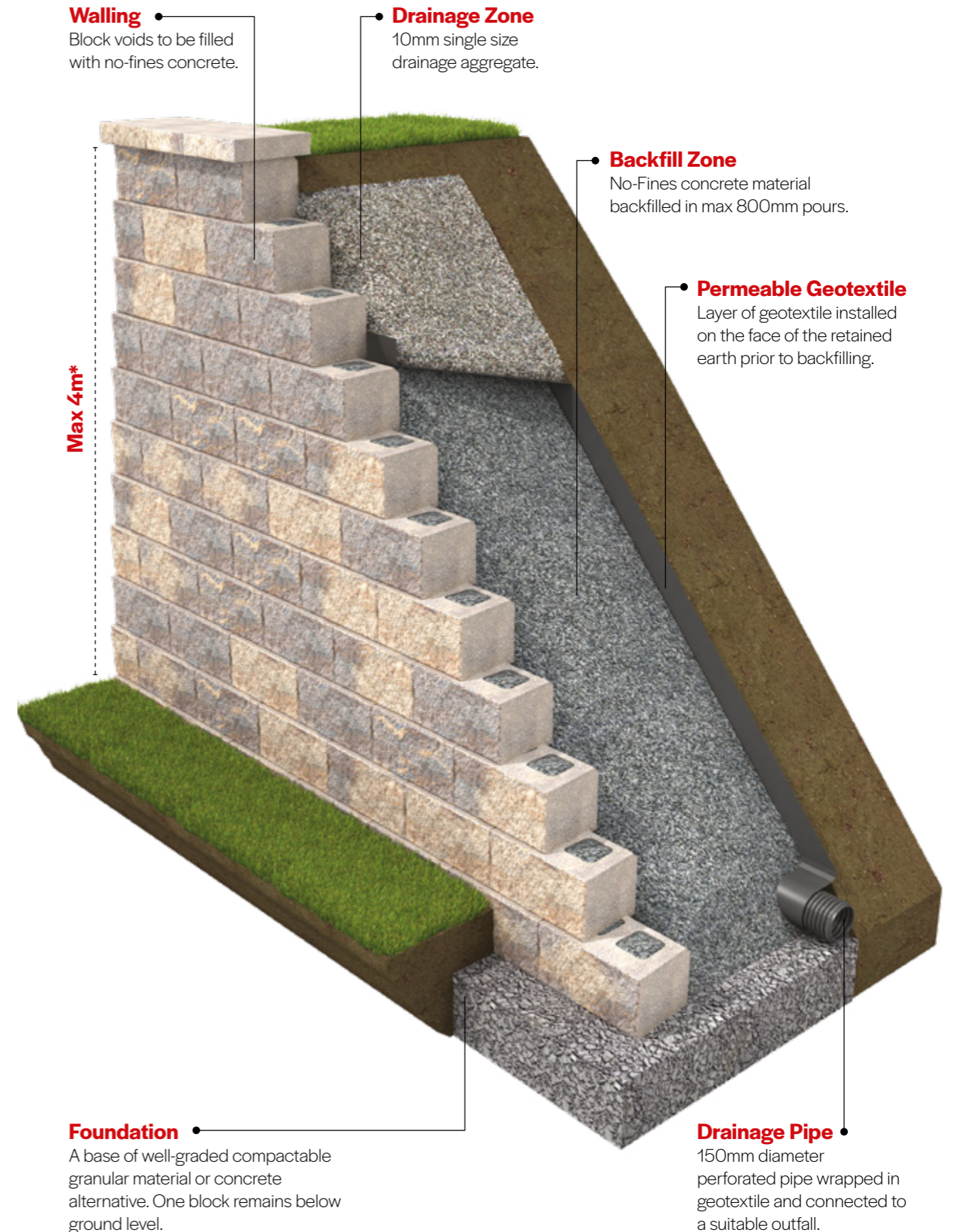

\*For higher walls please contact Tobermore technical department

## C20/25 Structural Concrete Backfill Reinforced Wall (max retained height 6m\*)

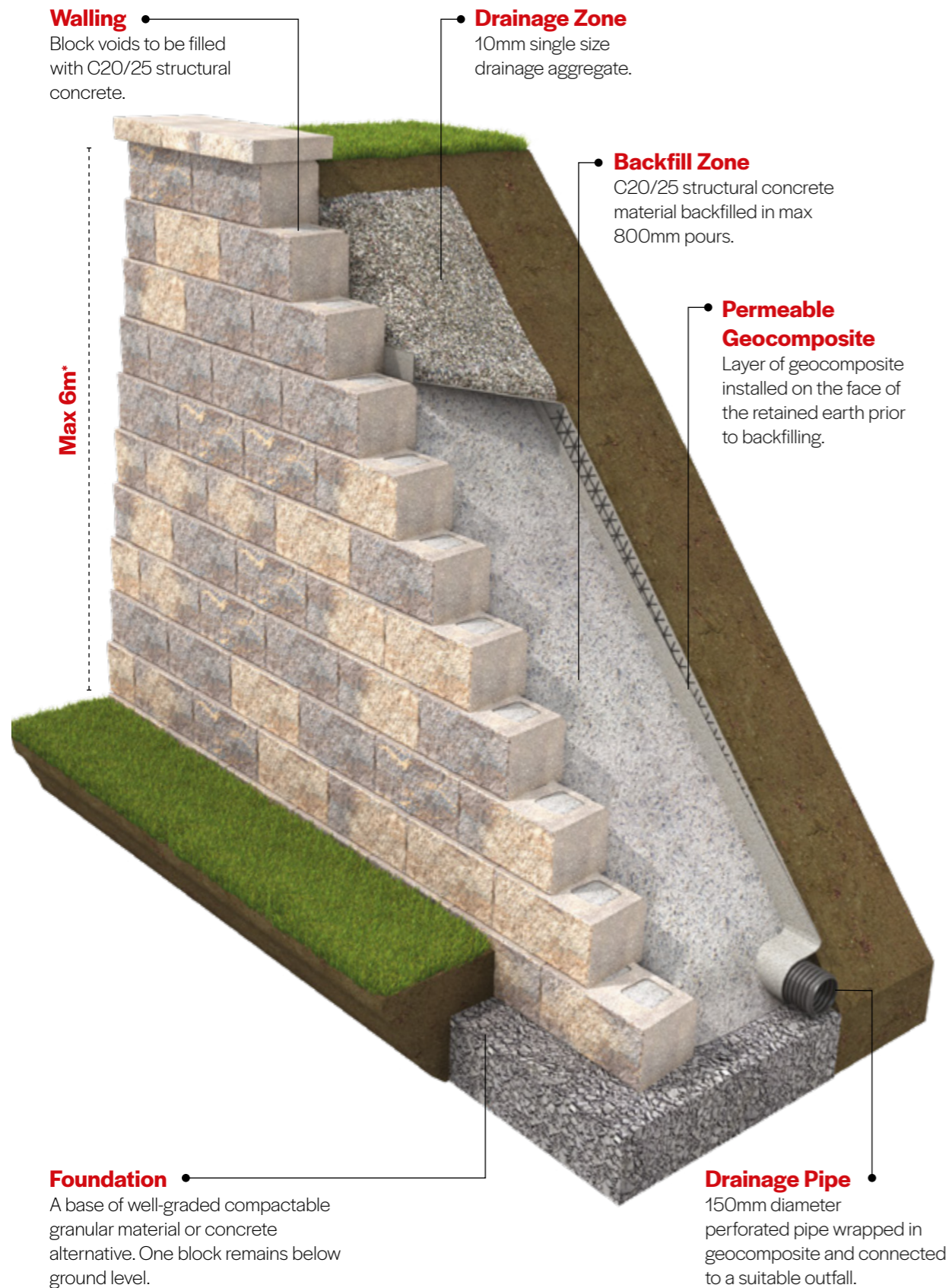

\*For higher walls please contact Tobermore technical department

# Secura Grand Concrete Backfill Wall Installation

### Preliminary actions

These installation instructions are common for both no-fines concrete backfill and C20/25 structural concrete backfill. However, please note the variation between geocomposite layer on the structural concrete option compared to geotextile on the no-fines installation.

#### STRUCTURAL DESIGN

**Important:** The design of any retaining wall requires the input of an engineer to assess the unique conditions of every site in respect of loads in conjunction with site and soil conditions. The advice and typical wall designs in this guide are for information only, to assist estimating and initial planning but should not be used for construction.

#### WORKING SAFELY

**Important:** Please refer to our safety notes on page 20 prior to commencement of any site works.

#### BATCH ORDERING

**Important:** If using a solid colour (Charcoal, Natural or Golden) please ensure you order from one manufacturing batch to avoid any colour shading which may occur.

#### FILL MATERIALS

**Important:** Please ensure that the specified fill materials (see page 18) are available on site before commencement.

### Step 1

#### Setting out & trench excavation

- Mark out the location of the wall by checking the design drawings or by agreement with the project engineer, architect or client.
- Please refer to the table below for typical foundation details or if there is an engineers' site-specific design this should be followed at all times. (Please refer to the table below for dimensions and recommended block courses below ground).
- Excavate the trench to a minimum 400mm deep and to a width equal to the concrete backfill zone. Remove any unsuitable material and replace it with compacted granular material. See specification for material on page 18. Ensure it is fully compacted using a plate compactor.

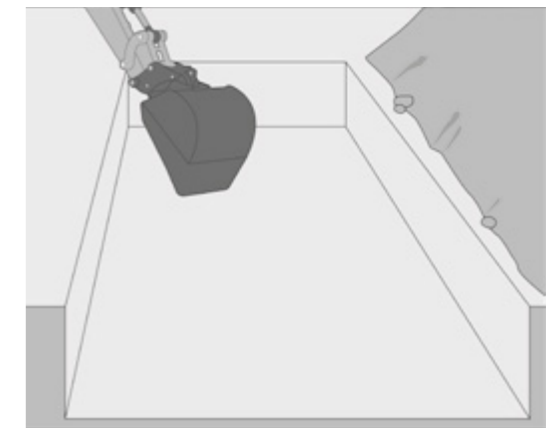

### Step 2

#### Laying the foundation

**Important:** If the wall is on a slope the foundation must be stepped. The top of the foundation must be at least 200mm below finished ground level. Lay a level foundation using one of the following two options:

- Granular material option:** Lay a well-graded compactable granular material as specified on page 18 and compact fully using a plate compactor to ensure a level base. The typical depth of the foundation should be 200mm after compaction.
- Concrete option:** Install a 200mm deep concrete foundation using C20/25 concrete.

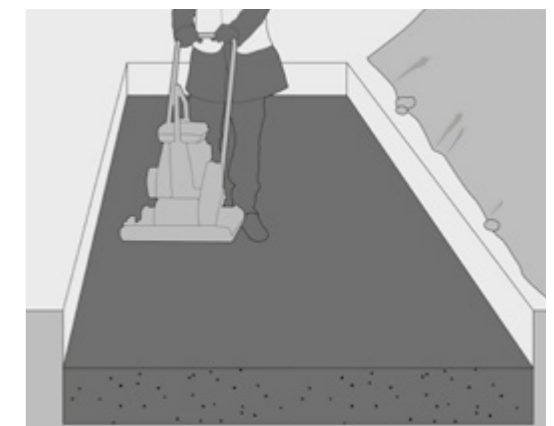

Product	Min. internal radius	Max. external radius	Typical trench width (mm)	Typical trench depth (mm)	Foundation material	Typical foundation depth (mm)	Block courses below ground
<b>Secura Grand Concrete Backfill</b>	2.4m to the back of the base course block or 2.17m to the front.	This will be dependent on the height of the wall. Please refer to page 86 of our Secura brochure.	400mm plus the width of the concrete backfill	400mm to accommodate one block plus foundation depth	Well-graded compactable material or C20/25	200 mm	1 (unless specified differently on the design drawings)



# Secura Grand Concrete Backfill Wall Installation

## Step 3 Installing the base course

- **Important:** The top of the base course when installed must be below finished ground level.
- **Block selection**  
Please ensure that you randomly select blocks from a minimum of three packs to achieve the desired colour blend. This should be done on the base course and for all other courses.
- **Block preparation**  
To ensure a level base course, remove the nib from the base of the blocks to be used on the base course using a bolster and club hammer.
- **Block Placement**  
Place the blocks onto the foundation and use a string line along the back of the blocks to check for alignment. Use a spirit level to ensure the blocks are level along their length and from front to back, as the aesthetics of the finished wall depend on the base course being level. Leave a gap of 2mm between the blocks to allow for any movement of the ground.
- **Front fill**  
Fill the gap in front of the base course with on-site soil and fully compact, level with the base course.

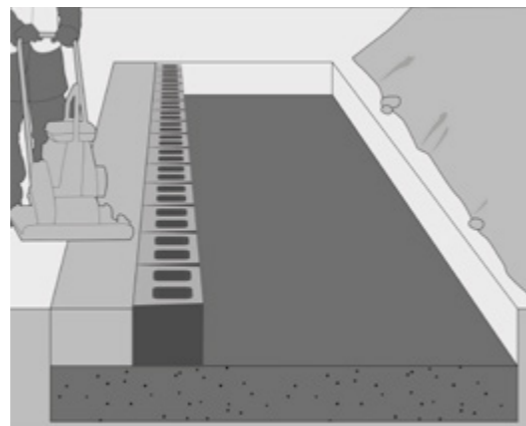
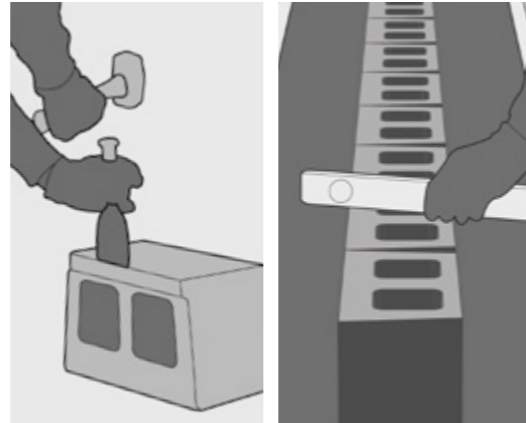

## Step 4 Geotextile/Geocomposite

- A geotextile permeable membrane should be installed against the retained ground. Where C20/25 structural concrete is used, a geocomposite membrane must be used.
- **Drainage Pipe:** Lay a perforated drainage pipe at the outer edge of the concrete backfill area. The pipe should connect to a suitable outlet/soakaway. The pipe should be wrapped in the geotextile to prevent clogging.
- **Fill the Block Voids:** Ensure the base course blocks are completely level and then fully fill the blocks voids with concrete, poker/tamp to ensure the voids are fully filled.

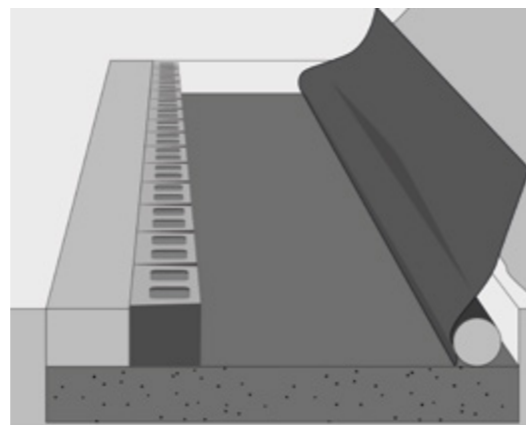

## Step 5 Laying further block courses

- **Important:** It is important that no more than four courses are constructed and backfilled at a time.
- Place the blocks on top of the base course ensuring that they are in running bond pattern in relation to the blocks on the base course. Vertical joints should not directly line up between courses.
- Push the blocks forward until the nib on the base of the block tightly locates against the course beneath.

- Use a spirit level to ensure the blocks are level as you build each course. Due to Secura's mortarless construction, the use of shims may be required occasionally to maintain the level of the block course.
- Continue to fill the voids with concrete, poker/tamp to ensure the voids are fully filled.

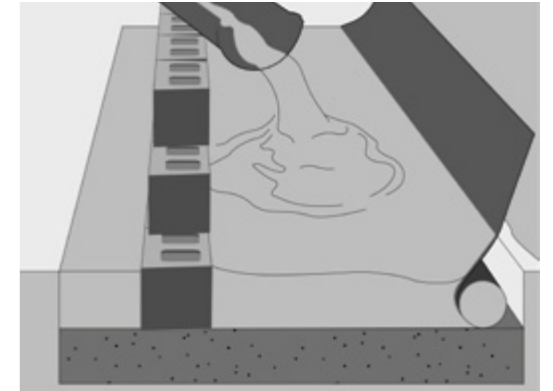

## Step 6 Backfilling the wall with concrete

- **Important:** The finished level of each pour must be a minimum of 75mm below the top of the block (to facilitate the nib on the rear of the next course). The maximum height of a pour should not exceed 800mm (4 courses).
- Backfill the wall with concrete to the required distance according to the engineer's design. Ensure the concrete fills the gaps at the rear of the blocks by poking/tamping. If using no-fines concrete, it should be sufficiently stiff to fill the voids and gaps between the blocks. See specification for no-fines concrete on page 18.
- Before the concrete has set, brush the top of the blocks to ensure there is no excess material. Brushing should be carried out on each course. Ensure that any concrete spilled onto the face of the blocks is cleaned off immediately.
- **Important:** Each lift of concrete backfill must be cured (overnight) prior to installation of further courses and subsequent backfilling.

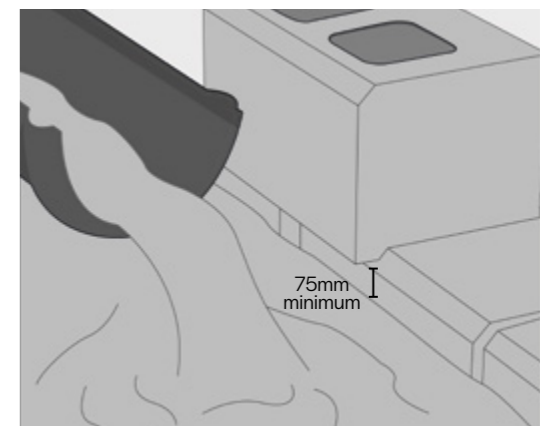

## Step 7 Completing the wall

- Repeat the block laying, void filling and backfilling process until the full height of the wall has been achieved.
- **Important:** The concrete backfill must not be placed in greater than 800mm vertical lifts per day to avoid destabilising the blocks while the concrete hardens. Top off the area behind the wall with soil.
- **Copings:** To install the Secura copings use a concrete exterior grade construction adhesive applied with a cartridge gun. Generously apply the adhesive to the block.
- For extra stability the last two courses of blocks can be bonded together as well as the coping blocks.

### Specification for No-Fines Concrete

Material	Use	Stone to cement ratio (by weight)	Unit weight (kN/m <sup>3</sup> )	Aggregate size	Water to cement ratio*
No-fines concrete	Backfill to retaining wall	6:1 to 7:1	18	Clean crushed stone typically 14-20mm	1:2

\*Water/cement ratio is a guide value only and should be assessed on site to ensure the correct consistency, avoiding an overly wet mix.

# Material Specifications

## FOUNDATIONS

**A minimum 200mm deep bed of well graded compactable granular material.**

### Recommended Specification – Type 1

- MOT Type 1 also known as DOT Type 1 named after the Department of Transport (DOT) specification for granular sub-base material.
- Must comply with the Department of Transport Specification for Highway Works, clause 803 (SHW 803). MOT Type 1 can be made from granite, limestone or clean crushed concrete.

The product is crushed to 40mm down to dust creating an aggregate containing a range of particle sizes that is easy to compact with excellent load bearing qualities.

**Or**

**A minimum 200mm deep foundation of structural concrete.**

### Recommended Specification – Type C20/25

Strength class	20/25
Cylinder strength (MPa)	20
Cube strength (MPa)	25
Modulus of elasticity (GPa)	30
Tensile strength (MPa)	2.2

## DRAINAGE AGGREGATE

- 10mm single sized drainage aggregate.
- Do not compact, to ensure a free draining path to drainage pipe at base of wall.

## GEOGRID MATERIAL

- Recommended Specification: Heusker/Fortrac 35/20 geogrid or equivalent. For BBA HAPAS certification Heusker/Fortrac 35/20 must be used.
- Geogrid must be installed perpendicular to the wall, rolled out in the direction of the principal reinforcement.

## BACKFILL AGGREGATE

A well graded granular compactable material.

### Recommended specification – Class 6I

Grading for 6I backfill as taken from BS Earthworks document series 600.

Sieve size	Grading
125mm	100
75mm	85-100
14mm	25-100
2mm	15-100
600 microns	9-100
63 microns	<15

- Maximum of 15% clay permitted.
- Material must be machine compacted in lifts of 200mm maximum

## SITE WON MATERIALS

Site won fill can only be used if tested to ensure compliance with Class 6I grading specification.

## NO-FINES CONCRETE BACKFILL

### Typical Specification for no-fines concrete.

Material	No-fines concrete
Use	Backfill to retaining wall
Stone to Cement ratio (by weight)	6:1 to 7:1
Unit Weight (kN/m <sup>3</sup> )	18.0
Aggregate size	Clean crushed stone typically 14-20mm
Water to cement ratio*	1:2

- \*Water/cement ratio is a guide value only and should be assessed on site to ensure the correct consistency, avoiding an overly wet mix.
- The optimum mix will facilitate the poking of no-fines backfill into the voids in and behind the Secura Grand facing blocks to create a monolithic structure.
- The no-fines concrete backfill must not be placed in greater than 800mm vertical lifts per day to avoid destabilising the blocks while the concrete hardens.

## C20/25 STRUCTURAL CONCRETE BACKFILL

### Recommended Specification – Type C20/25

Strength class	20/25
Cylinder strength (MPa)	20
Cube strength (MPa)	25
Modulus of elasticity (GPa)	30
Tensile strength (MPa)	2.2

- The C20/25 concrete backfill must not be placed in greater than 800mm vertical lifts per day to avoid destabilising the blocks while the concrete hardens.

## DRAINAGE PIPES

A 150mm perforated drainage pipe should be wrapped in geotextile to prevent blockages.

## FENCE/BARRIER INSTALLATIONS

Posts to be installed in pre-positioned 300mm diameter. PVC pipe sleeves and fully filled with C20/25 structural concrete following completion of the wall structure.

Post depths are determined based on the individual project conditions.

## COPING ADHESIVE

Secura Copings to be secured with a generous application of exterior grade construction adhesive to the top of the Secura blocks.

## MOUNTING LOAD BEARING FIXTURES

If load bearing fixtures such as hand rails are to be fitted then these should be identified at the planning stage and the block voids should be filled with C20/25 concrete at the appropriate sections of wall. This is to ensure the maximum anchorage for the fixings in the event that they penetrate the block voids.

## CUTTING BLOCKS

The use of a water suppressed masonry saw is recommended to reduce the risk of staining. Please observe regulations with regards to the use of PPE.

# On-site Safety & Maintenance

## Wall Design

The design of any retaining wall requires the input of an engineer to assess the unique conditions of every site in respect of loads in conjunction with site and soil conditions. Correct site assessment and appropriate wall designs are the essential prerequisites to safety during construction.

## Risk Assessments

It is the responsibility of the contractor to ensure that a full site-specific Health & Safety risk assessment has been carried out prior to construction.

Adequate fall protection should be constructed to provide a safe working at height environment for all employees in compliance with current legislation. Please ensure compliance with the latest construction Health & Safety regulations. There are specialist companies who can provide fall protection solutions.

In our experience scaffolding can be used successfully to construct fall protection guard rails. The scaffolding and rails should rise as the wall height rises and must comply with Health & Safety regulations. A typical restraint is shown here in relation to a Secura Grand retaining wall.

## Cutting Blocks

The use of a water suppressed masonry saw is recommended to reduce the risk of staining. Please observe regulations with regards to the use of PPE.

## Maintenance

Secura segmental retaining walls require very little maintenance. However, where any specific requirements have been set out in the project engineers wall design, these should be adhered to.

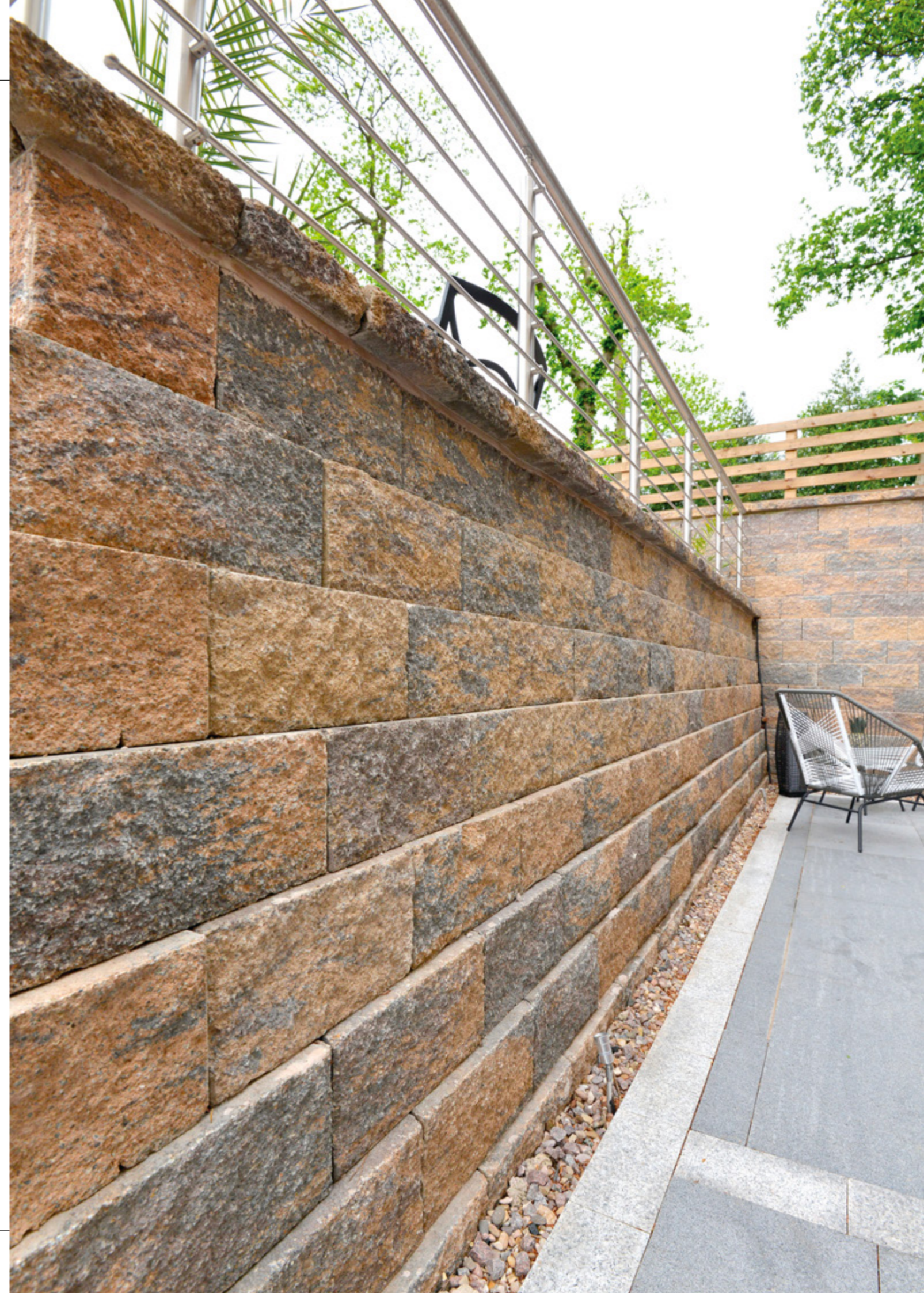

# Instructions & Warnings

## As referred to in Tobermore's Conditions of Sale

### CORE TERMS (PAVING & WALLING)

#### Product

All products should be carefully inspected for defects or damage upon delivery and prior to being laid or fitted.

#### Product Information

Within Tobermore, design and development of products is a continuing process, and product information is subject to change without notice. Accordingly, please check with Tobermore to ensure that the product information you have represents the most up-to-date product information.

#### Prior to Installation

Prior to opening the packs check that all the batch code labels match. The batch code labels can be found on the outer packaging. For example, 04D22N. It is good practice to sort products to ensure consistency of colour, texture and dimensional tolerance. Any defects must be reported without delay. If products are installed with any form of defect which was clearly apparent prior to installation the installer will be responsible for all costs incurred to rectify the issue.

#### Installation

All products should be installed in accordance with the latest British Standard.

#### Colour/Shade & Texture

Tobermore produces paving and walling products with excellent density and durability. All products are manufactured in batches using naturally extracted raw materials including aggregates, pigments and cement etc. Products such Braemar, Sienna, Fusion, Mayfair Flags, Manhattan, City Pave and Fusion Kerbs are manufactured using premium naturally occurring granite aggregates. To achieve their final appearance some products undergo secondary processes, this involves shot blasting or grinding the surface of the product.

Whilst we have several factory procedures in place to help control shade, colour and texture within and between batches we cannot guarantee consistency. This is due to the natural materials and secondary processes. Therefore, slight variations in the finished products is normal between and within batches. These variations actually enhance the character and natural beauty of the products.

To achieve the best possible finish we recommend the following advice is followed to evenly distribute any slight variations in shade, colour and texture over a large area.

When the circumstances allow complete one area of paving, one retaining wall or one house / building by using products taken from the same batch. This is achieved by checking the batch code label displayed on the packs.

Always, thoroughly mix products from a minimum of three packs.

Where products are supplied in packs with vertical slices always take them "vertically slice by slice" this ensures that colours are distributed evenly.

When the circumstances do not allow the use of products from the same batch then it is extremely important to minimise possible colour banding /shading by always, thoroughly mixing products from a minimum of three packs concurrently with some overlap between deliveries / batches.

Where products from different batches are being installed in the same area of paving, wall or building it is the installers responsibility to carry out a colour match check by comparing colours from each batch. If a noticeable variance in colour / shade or texture is visible, do not proceed with the installation and contact your supplier for further guidance.

Mixing thoroughly from a minimum of three packs is of particular importance when installing single colours such as Golden, Buff, Natural, Charcoal, Graphite, Silver, Mid-Grey, Sandstone, Alto Silver, Aaron Stone, Jura Grey and Innis Black.

During installation the installer must make regular visual checks to ensure the blending of colours is consistent.

We would always recommend that when purchasing products, especially in larger quantities, that they are all ordered at the same time.

Please note that the colour of new products will inevitably vary compared to those that have been installed for a period of time as weathering does take place.

All colour illustrations are as accurate as the printing process will allow. For a more accurate colour match please refer to actual product samples, which can be provided. Colours and textures illustrated are representations and therefore should not be expected to be an exact match.

The overall visual appearance of a completed installation should only be assessed from the normal viewing distance. Variations in colour/shade and texture are technically harmless, do not affect the products performance and are not deemed to be a product defect.

We will not be held liable for any discolouration or staining caused to product which has been stored incorrectly.

Note: Whilst we strive to ensure consistency, complimentary products such as Kerb Specials, Step Flags, Facing Brick Specials, Historic Circles etc. may not be an exact colour / texture or shade match to the standard version of the product as they will have been manufactured at varying times using different processes.

#### Tegula

Tegula is manufactured using a secondary process that distresses the edges and corners of the blocks to give the desired aged antique appearance. The process randomly distresses the blocks, therefore some blocks will be more distressed than others will, this is completely normal and does not affect the product performance.

#### Staining

Some chemicals that are commonly used in gardens such as lawn feed containing Ferrous Sulphate can stain concrete products. Any chemicals that are spilt must be removed immediately by rinsing away with clean water. Please check the information on the instruction label of the container holding the chemical.

#### Moisture

Occasionally, after installation, some units may show variations in shade and have a patchy appearance. This is due to the varying amounts of moisture within the concrete and the ground. The drying out process of concrete continues in-situ after installation. Some units may also retain more moisture than neighbouring units and take longer to dry out. This is caused by the variations in density of the naturally extracted aggregates used in the manufacturing process. Given time and natural weathering, the capillaries within the surface of the concrete will gradually close and any patches or moisture retention will dissipate as the product matures. This does not affect long-term performance.

#### Efflorescence

Efflorescence is a crystalline deposit that occurs naturally on the surface of concrete materials. It usually appears as a white deposit but can also be brown or yellow in appearance. Tobermore use market-leading technology to significantly suppress the occurrence of efflorescence, however, if it occurs, it may mask the colour of the product for a period of time, but tends to be washed away gradually by rain. Tobermore do not replace products with efflorescence. Packs of products which have had packaging removed should always be re-covered with appropriate packaging to prevent the occurrence of secondary efflorescence.

#### Surface Scratches

Minor scuffs or bruises may occur during delivery, movement onsite, and installation (for example, during any plate vibrating process). In Tobermore's experience, these marks usually weather off through time.

To reduce the risk of surface scratches we strongly recommend the use of a vibrating plate with a rubber protective mat.

#### Ordering

To avoid waste, please ensure that your contractor accurately measures the area on site before ordering products. In Tobermore's experience, dimensions taken from a project plan can vary significantly from the final layout.

Depending on the layout of the project, we recommend ordering an additional 2 - 5% of material to allow for cutting, detailing and wastage.

#### Manufacturing & Quality Systems

Tobermore is a BS EN ISO 9001, BS EN ISO 14001 and BES 6001 registered company. Tobermore uses an integrated management system to manage all health & safety and environmental issues.

#### Product Maintenance

Routine cleaning and maintenance is required to keep the overall appearance of products in pristine condition.

All concrete products can develop algae, lichen, and moss growths due to environmental conditions and may require cleaning. Areas adjacent to plant borders and trees may discolour from transfer of plant-life. Tobermore cannot accept responsibility for any of these conditions.

#### Queries & Complaints

Please contact one of Tobermore's Paving & Walling Centres or offices (contact details at [www.tobermore.co.uk](http://www.tobermore.co.uk)) with any queries or complaints. Any complaints must be notified to Tobermore without delay.

### CORE TERMS (PAVING ONLY)

Paving installed unbound should have a close joint width of 2-5mm to allow for the dimensional tolerances of products and to create a gap to allow the brushing in of kiln dried jointing sand. The straightness of lines will be dependent on workmanship and product tolerances. String lines must be used to help achieve straight lines. Tobermore do not recommend Butt jointing as this will make achieving straight lines more difficult.

#### Product Maintenance

Light coloured paving blocks and flags emphasise tyre marks and oil spills on the driveway. Please note that these products will need more maintenance if overall appearance is to be maintained.

#### Initial Cleaning

When an area has just been paved, allow it to settle for a few days. After this, you may wish to lightly hose down the paving to remove any excess sand or dirt. The area should then be treated with a weed killer suppressant 2-3 times per year as required.

#### General Cleaning

Paving requires regular maintenance, including regular sweeping to prevent the build up of detritus. Tobermore recommends that paving is cleaned 2-3 times per year.

For general cleaning of dirt and algae, vigorous brushing with a stiff yard brush with plenty of hot detergent solution (washing up liquid or non-bio washing powder), thoroughly rinsed with clean water, should suffice. Repeated treatment may be required for paved areas sited beneath trees or in permanent/near permanent shade.

A light power hose at medium pressure is generally all that is required to clean general dirt and grime. Any jointing material which is removed must be replaced. Do not use high pressure powerwashers as aggressive power-washing can damage the product surface. A trial area should be tested before large scale powerwashing takes place.

#### Moss, Lichen and Algae

Thick growths of moss or lichen must be removed first by scraping out the joints and then treating the area with a moss killer such as anti-moss paving cleaner. Anti-moss is designed to remove moss, lichens and algae. It is best applied in dry weather. After being applied it will take a few days to be fully effective. Once the moss and lichens have been killed, they can easily be brushed off. Anti-moss also leaves a residue in the sand joint which will help reduce the likelihood of re-growth. The manufacturer's instructions should always be followed when using any cleaning agent.

#### Weeds

Large weeds should be removed by hand and then the area treated with a weed killer (available from any good garden centre). Smaller weeds can then be treated directly with weed killer and these weeds should start to die within days. The manufacturer's instructions should always be followed when using any weed killing agent.

#### Block Paving Sealer

It is possible to seal block paving with a resin material which combats staining and weed growth and which also enhances colour and appearance. The acrylic sealer is sprayed onto the block paving and forms a 'skin' on top of the paving and the jointing material giving an easily maintained finish. The manufacturer's instructions should always be followed when using any sealing agent.

### FOR HYDROPAVE PRODUCTS

#### Installation - Hydropave

Tobermore recommends that its Hydropave products be installed in conjunction with a BS EN 7533-13:2009 designed permeable paving system.

**Note:** A permeable paving design relies heavily on using the correct aggregates. Prior to installation, we would ask you to test both the 4/20mm coarse graded aggregate and also the 6.3-2mm bedding and jointing grit as per the relevant British Standard specification (BS EN 13242:2002). In particular, the material should be categorised as LA20 according to Table 9, SZ18 according to Table 10 and MDE15 according to Table 11 within this standard. The grit should be insoluble in dilute hydrochloric acid and should be naturally occurring material. In our experience, incorrect use of aggregates is one of the most common reasons for failure of a permeable paving system.

#### Joint Filling

All joints must be filled to the top with 6.3 – 2mm grit to prevent movement and spalling of the blocks. We recommend that after a few weeks use, any joints which have settled and are not full, are topped up with grit. Joints should be kept filled at all times. You will need approximately one tonne of grit for every 100m<sup>2</sup> of 80mm paving.

**Note:** Care should be taken that the permeable joints do not become contaminated as work on the scheme is completed. Special care needs to be taken when soft landscaping is carried out so that soil does not enter the joints. When this type of work is being carried out, the surface of the permeable paving should be protected by an appropriate cover to protect the joints from being contaminated.

#### Hydropave Maintenance

Please refer to Tobermore's detailed 'Permeable Paving Maintenance Guidelines' available on our website: [www.tobermore.co.uk](http://www.tobermore.co.uk)

### FOR EASYCLEAN PRODUCTS

#### Handling & Installation

During installation, the surface should be protected at all times from scratching and abrasion.

Once the protective glue dot has been removed do not stack flags directly on top of each other.

Use a plate vibrator with a rubber mat.

Do not scratch the surface with tools. (Spade, trowel etc.)

#### User advice

Do not drag garden furniture across the surface of the flags.

Do not pressure wash.

Do not use chemical cleaning products (e.g. solvents/acids).

### FOR FACING BRICK & COUNTRY STONE PRODUCTS

#### Important Note:

Where the circumstances allow, it is beneficial to complete one building / structure using bricks taken from one batch and mixed on site from a minimum of 3 packs to avoid colour banding / shading. If the circumstances do not allow for this then it is important to minimise the possibility of banding / shading by always mixing bricks from 3 packs concurrently with some overlap between deliveries.

Where the site conditions allow, it will also be beneficial to take receipt of as many bricks as possible at an early stage to maximise colour consistency throughout the site.

#### Installation – Facing Bricks

Please refer to Tobermore's detailed 'Guide to the use of Tobermore Concrete Bricks' available on our website: [www.tobermore.co.uk](http://www.tobermore.co.uk)

#### Installation – Country Stone

Tobermore's Country Stone products are designed to recreate traditional stone sizes and to co-ordinate with standard cavity wall construction. When used in housing projects, a clear cavity must be retained.

All work must be protected during construction and must be designed and built in accordance with accepted industry standards and practice. Builders familiar with conventional brickwork will find that similar installation principles apply.

Joints can be finished flush or tooled depending on the overall effect required. Raked joints

are not recommended. It is vital that all horizontal and vertical joints between Country Stone blocks must be compacted and free from voids. Shell bedding should not be used.

#### Good Practice during Construction - Facing Bricks & Country Stone

- If mortar dry's on the surface of the bricks it will stain the product and may not be removed.
- Mortar extruding from joints should be removed when the mortar is wet and during the process of laying.
- Any mortar smears on the brick surface should be removed by dry or wet brushing.
- Scaffolding should be installed as per regulatory instructions. Please note that mortar can drop and hit the scaffolding and then also go onto the wall. You should inspect the work area at all times to ensure the brick surface remains mortar free.
- When it rains be careful that any wet mortar on the scaffolding does not get 'splashed' onto the wall.
- When work stops or is interrupted by inclement weather conditions, brickwork should be protected immediately with polythene sheeting that is held in place with a suitable fixing. If new brickwork is not protected efflorescence, patchy mortar colour, patchy brickwork and staining can occur.
- Bricks should always be covered with polythene sheets to avoid getting damp or dirty when not being used.

#### General Cleaning Advice - Facing Bricks & Country Stone

- It is always important to keep bricks as clean as possible while laying and tooling. See Good Practice above.
- If mortar has been allowed to dry on the surface of the bricks the options you have to clean it off are as follows; Each process should be tested first and should ensure the facing bricks are not damaged - Dry brushing b. Wet brushing c. Using a 'like coloured' brick to rub the stained brick d. Pressure washing - should only be used as a last resort as it will damage the surface and the mortar joint if not completed correctly (this method cannot be attempted until the area has been allowed to set for a minimum of 7 days).
- Acid cleaning should be avoided.

#### Movement Joints and Mortar Guidance - Facing Bricks & Country Stone

1. NHBC recommends that walls constructed of concrete masonry units should have vertical movement joints included every 6m to allow for drying/shrinkage, see PD6697:2019, maximum ratio for brickwork panels is to be 3:1 length : height. PD6697:2019 gives advice on joint positions, the benefit of brickwork reinforcement at window openings is also covered in the same document. Movement joints should be planned prior to commencing any construction to enable them to be concealed behind down pipes etc. and ensure the aesthetics of buildings are maintained.
2. It is important to ensure that the mortar specified for the construction is suitable for the contract, see table 15 of PD6697:2019 - class M4 is the maximum recommended for normal external masonry walls. This should not be exceeded when using Tobermore Concrete facing bricks and Country Stone Walling.
3. We would recommend that you discuss this guidance with all parties involved in the design, construction and installation of the scheme. We also recommend that you refer to BS EN 1996-1-1 and PD6697:2019.
4. Specific professional advice should be obtained at all times before commencing building work.

#### Important Guidance Information: Tobermore Concrete Facing and Country Stone Walling

1. Professional advice, specific to the project, should be sought before commencement of the building work.
2. Tobermore Facing Bricks have different properties to clay bricks especially in relation to moisture movement. Please refer to 'Guide to the Use of Tobermore Concrete Facing Bricks', which is available on request or at [www.tobermore.co.uk](http://www.tobermore.co.uk)
3. Tobermore recommends that vertical movement joints be spaced at no more than 6m apart. Panels of brickwork where the length: height ratio exceeds 3 are particularly vulnerable to cracking; if they cannot be avoided, they should include movement joints at closer centres.
4. Movement joints should be planned prior to any construction so that they can be concealed behind drainpipes etc. Further guidance on moisture movement is available in the 'Guide to the Use of Tobermore Concrete Facing Bricks' and BSI documents BSEN 1996 (Eurocode 6) and PD 6697 (Recommendations for Design).
5. It is important to ensure that the mortar specified is suitable for the construction, see Table 15 of PD 6697. Mortar of strength class M4 will generally be suitable. Please refer to 'Guide to the use of Tobermore concrete facing bricks', which is available on request.
6. When building with dissimilar materials allowances should be made for differential movement. Design guidance from a structural engineer should be sought when combining dissimilar materials such as clay and concrete facing bricks. Examples of using dissimilar materials would be where a clay brick is used to build up to the dpc level and then Tobermore concrete facing bricks are used above the dpc. In some circumstances the dpc acts as a slip plane to separate the two materials which helps to dissipate tensile stress. However expert guidance should always be sought as to ensure structural stability as further slip planes or bed reinforcement may need to be incorporated into the design.
7. It is recommended that this guidance is discussed with all persons involved in the design and construction of the building work.

### FOR SECURA PRODUCTS

#### Installation - Secura

All Secura products should be installed in accordance with British Standard BS8002. When constructing a retaining wall, ensure that you follow the design provided by the scheme engineer.



**Contact Us**

GB: 0844 800 5736

NI: 028 7964 2411

ROI: 048 7964 2411

**Email**

[technical@tobermore.co.uk](mailto:technical@tobermore.co.uk)

[sales@tobermore.co.uk](mailto:sales@tobermore.co.uk)

Paving



Walling & Retaining Walls



Facing Brick

